

THESE DRAWINGS ARE THE PROPERTY OF QUALTEK ELECTRONICS AND NOT TO BE REPRODUCED FOR OR COMMUNICATED TO A THIRD PARTY WITHOUT THE EXPRESS WRITTEN PERMISSION OF AN OFFICER OF QUALTEK ELECTRONICS.

REVISION			
REV.	DESCRIPTION	DATE	APPROVED
B	RoHS Compliance	06-01-06	DP

1. PHYSICAL DIMENSIONS

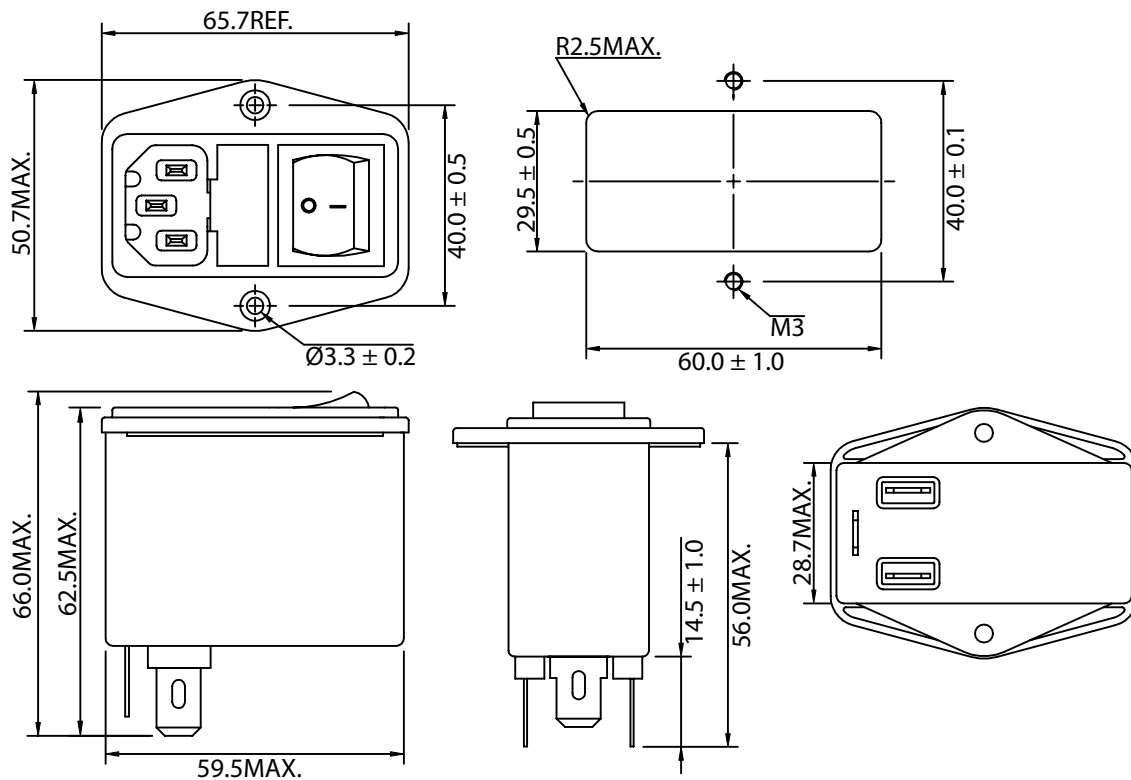

ELECTRICAL CHARACTERISTICS:

- 1-1. VOLTAGE RATING.....115/250VAC
- 1-2. CURRENT RATING
 A. @ 115 VAC.....3 A RMS MAX
 B. @ 250 VAC.....3 A RMS MAX
- 1-3. OPERATING FREQUENCY.....50/60Hz
- 1-4. LEAKAGE CURRENT: EACH LINE TO GROUND
 A. @ 115 VAC 60Hz.....0.20 mA MAX
 B. @ 250 VAC 50Hz.....0.40 mA MAX
- 1-5. HIPOT RATING (FOR ONE MINUTE)
 A. LINE TO GROUND.....2250 VDC
 B. LINE TO LINE.....1450 VDC
- 1-6. MINIMUM INSERTION LOSS IN dB: (AT 50 OHM SYSTEM)

FREQ. MHz	.01	.05	.10	.15	.50	1.0	5.0	10	30
COM. MODE dB	2	10	12	15	30	35	35	40	35
DIF. MODE dB	/	2	8	8	15	20	30	35	35

- 1-7. OPERATING TEMPERATURE.....-25° TO +85° C
- 1-8. SAFETY:
- 1-9. USE 5X20mm FUSE
- 1-10. RoHS COMPLIANT

CONTROLLED

2. ELECTRICAL SCHEMATIC

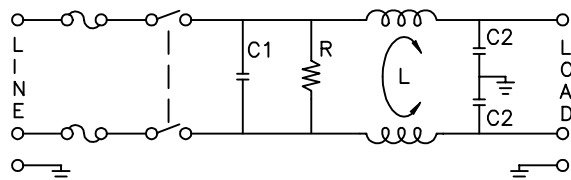

L: 2.0mH
 C1: 0.22uF
 C2: 2200pF
 R: 1.0MΩ

Dim range (mm)	Tolerance +/- (mm)	Qualtek Electronics Corp. PPC DIVISION		
		Part Number: 880-03/002		
0-1	0.15	Description: EMI FILTER		
1-6	0.20			
6-18	0.30	UNIT: mm	REV. B	
18-50	0.50			
50-120	0.70	Drawn / Date	Checked / Date	Approved / Date
120-250	0.90	B.ZHANG 03-18-04	03-18-04	JJH / 03-18-04
250-500	1.20			